

2017 **navien** **PRODUCT CATALOGUE**

Home IoT / Video Phone / Digital Apartment System

Contents

About KD ONE	03
Navien Home IoT	04
Home Automation System	
Video Phone	08
Video Phone	
Digital APT Video Phone	17
Digital APT Video Phone	
Door Camera	22
Door Camera	
Multi Button Door Camera	
Multi APT System	30
Lobby Phone	
Guard Phone	
Main Controller	
Accessory	38
Sub Interphone	

KD ONE Co., Ltd

KyungDong's focus is - and will always be - to create the most comfortable environment possible for customers all around the world.

Three affiliates of KyungDong Group share this vision together.

KD One is composed of two business divisions.

Network business is dedicated to develop state-of-the-art networking and control technology to enhance safety and convenience of the life of our customers.

Ceratech business is a manufacturer of eco-friendly construction & industrial materials, providing cleaner and greener living environment.

KD Navien supplies the best quality of boilers, water heaters, air conditioners, and heat recovery ventilators possible throughout the world.

KD Everon develops and produces core components for HVAC products.

These three affiliates aspire to become world-leading corporations in their respective areas by continuously developing creative technology solutions while moving towards their common goal of enriching the Customer's lives.

History

2016.01. Appointment of new President Koo, Yong Suh

2015.12. Lobby Phone was selected as a Good Design Selection of Industrial Design Promotion Act.
2015.11. KD One was awarded the K-ICT IoT AWARD 2015 by Ministry of Science, ICT and Future Planning.

2014.02. Wall Pad was awarded the 2014 IF Design Prize in the control technology field for buildings

2012.07. KD Ceratech and KD Network was merged into KD One
2012.03. Video Phone was awarded the 2012 IF Design Prize in the control technology field for buildings

2011.03. Video Phone was awarded the 2011 IF Design Prize in the control technology field for buildings

2010.06. Changed corporate name to Kyung Dong One Co., Ltd. / Spin-off of Kyung Dong Network

2009.08. Launched home network/home automation system 'UbiHome'
2009.06. Appointment of new President Choi, Jae-bum

2006.06. Launched agencies for home network products
2006.01. Awarded the First Prize in the Top 100 Outstanding Patents Awards

2005.09. Demonstrated network products at 2004 London Expo
2005.06. Launched 'e-Family' home network key solution

2003.12. Changed corporate name to Kyung Dong Network Co., Ltd.
2003.04. Kyung Dong Electronics merged with KDSS Co., Ltd.

1983.07. Opened Seoul office

1982.02. Samson Co., Ltd founded

1981.10. Samson Trading founded





Comfort Living

NAVIEN Home IoT systems are specially designed to deliver the full safety and convenience to the residence.



White

Black

Recommended Products



Door Camera UDP-300N



Door Camera UDP-735

UHA-1010

10.1"(25.6cm) Digital APT Complex Video Phone



FEATURES & BENEFITS

- Call and Talk to visitor, Door release, Detour call to another flat
- Call and Talk to Guard Phone, Emergency Alarm and Notice Function
- Control for internal lighting/gas/heating
- Security functions (Emergency, Burglary alarm & Gas leakage detection)
- User friendly interface & Touch screen
- Still images recordable (Max 64cuts)

Specifications

POWER SOURCE	100-240V AC , 50-60Hz (Input +12V DC, 1.0A)
COLOR	WHITE / BLACK (Optional)
DISPLAY	10.1 inch(25.6cm) TFT Color LCD (NTSC/PAL Convertible)
COMMUNICATION	Hands free
MOUNT TYPE	Wall Flush-mounted type
WIRING	1) Door Camera : 4 wires (Polarity) 2) Main Controller : 8 wires (polarity)
DISTANCE	1) To Door Camera : 28m(Φ0.5), 50m(Φ0.65) 2) To Guard Phone : 1km(Φ0.65)
DIMENSIONS	324(W) X 198(H) X 14(D) mm
FLUSH BOX SIZE	350(W) X 261.5(H) X 100(D) mm
PERFORATE SIZE	215(W) X 162(H) mm

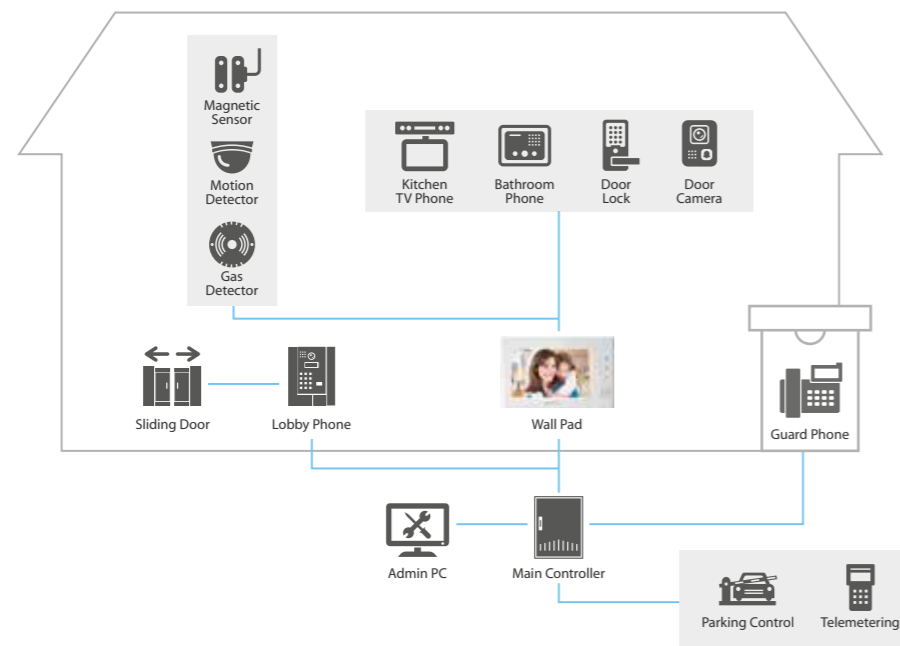
System Diagram

Black

White

Recommended Products



Door Camera UDP-300N



Door Camera UDP-735

UHA-750

7"(17.8cm) Digital APT Complex Video Phone

FEATURES & BENEFITS

- Call and Talk to visitor, Door release, Detour call to another flat
- Call and Talk to Guard Phone, Emergency Alarm and Notice Function
- Control for internal lighting/gas/heating
- Security functions (Emergency, Burglary alarm & Gas leakage detection)
- User friendly interface & Touch screen
- Still images recordable (Max 64cuts)

Specifications

POWER SOURCE	100-240V AC , 50-60Hz (Input +12V DC, 1.0A)
COLOR	WHITE / BLACK (Optional)
DISPLAY	7 inch(17.8cm) TFT Color LCD (NTSC/PAL Convertible)
COMMUNICATION	Hands free
MOUNT TYPE	Wall Flush-mounted type
WIRING	1) Door Camera : 4 wires (Polarity) 2) Main Controller : 8 wires (polarity)
DISTANCE	1) To Door Camera : 28m(Φ0.5), 50m(Φ0.65) 2) To Guard Phone : 1km(Φ0.65)
DIMENSIONS	274(W) X 188(H) X 11(D) mm
FLUSH BOX SIZE	350(W) X 261.5(H) X 100(D) mm
PERFORATE SIZE	201(W) X 148(H) mm

System Diagram

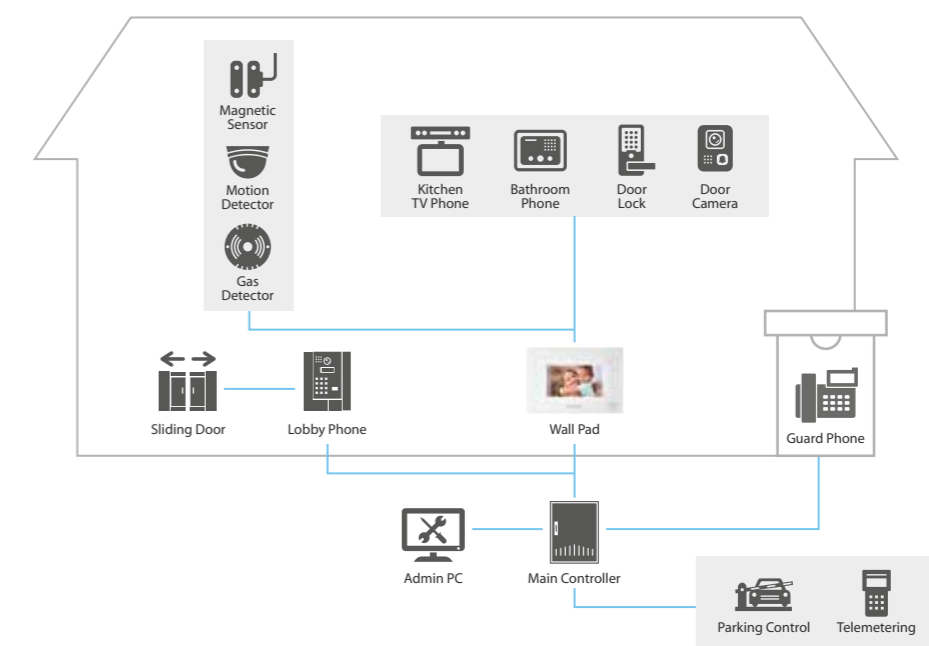



Secure, comfortable and smart

From IP to 2 wires communications, enrich and improve the quality of your life at home.









NAVIEN IoT HUB





Recommended Products

 Door Camera UDP-310	 Smart Plug	 Temp/Humidity Sensor
 Motion Sensor	 Door Sensor	 Boiler+IoT Linker

UHA-777

Digital Color LCD Hands-free 7"(17.8cm) IoT HUB

FEATURES & BENEFITS

- Talk with the visitor via smart phone APP in video mode, when the visitor calls from the door.
- Multifunctional Videophone equipped with IoT Hub
- Interconnect with Zigbee IoT Devices(Max 22 EA)
- Still or Video Recordable(Optional - Micro SD)
- Security functions with Wireless Motion sensor and Door sensor
- Support iOS/Android devices(Up to 4 users)
- Support multiple users
- Built-in 2M Pixel Camera

Specifications

POWER SOURCE	100-240V AC , 50-60Hz (+14V DC, 1.5A - Optional)
COLOR	WHITE
DISPLAY	7 inch(17.8cm) TFT Color LCD (NTSC/PAL Convertible)
COMMUNICATION	Hands free
MOUNT TYPE	Wall surface mounted type
WIRING	Door Camera : 4 wires (polarity)
DISTANCE	To Door Camera : 28m(TIV Ø0.5), 50m(TIV Ø0.65), 70m(TIV Ø0.8) (Up to the last Video Phone)
DIMENSIONS	288.5(W) X 170(H) X 29(D) mm
Wi-Fi	IEEE 802.11 b/g/n
ZigBee	IEEE standard 802.15.4

Installation Example

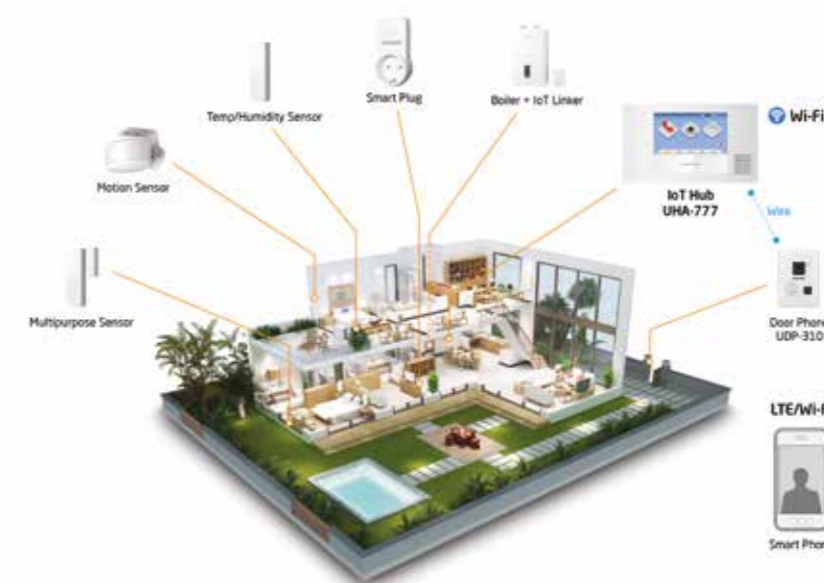

* The option for IoT devices can be changeable according to the customer's choice

NAVIENT IP VIDEO PHONE



Recommended Products



Door Camera
UDP-300/300N/305



Door Camera
UDP-400



Door Camera
UDP-500 Series



Door Camera
UDP-600 Series



Door Camera
UDP-735

UHA-775

Digital Color LCD Hands-free 7"(17.8cm) IP Video Phone

FEATURES & BENEFITS

- Talk with the visitor via smart phone APP in video mode, when the visitor calls from the door.
- Access to the home inside via built in camera or door camera in smart phone APP.(Optional-UHA-775SGV)
- Still or Video Recordable(Option - Micro SD)
- Security functions with Magnetic and Moving Sensor
- Support iOS/Android devices
- Support multiple users

Specifications

POWER SOURCE	100-240V AC , 50-60Hz (+14V DC, 1.5A - Optional)
COLOR	WHITE
DISPLAY	7 inch(17.8cm) TFT Color LCD (NTSC/PAL Convertible)
COMMUNICATION	Hands free
MOUNT TYPE	Wall surface mounted type
WIRING	1) Door Camera : 4 wires (polarity) 2) Magnetic Sensor : 2 wires (polarity) 3) Motion Detector (polarity)
DISTANCE	To Door Camera : 28m(TIV Ø0.5), 50m(TIV Ø0.65), 70m(TIV Ø0.8) (Up to the last Video Phone)
DIMENSIONS	288.5(W) X 170(H) X 29(D) mm
Wi-Fi Module	IEEE 802.11 b/g/n

System Diagram

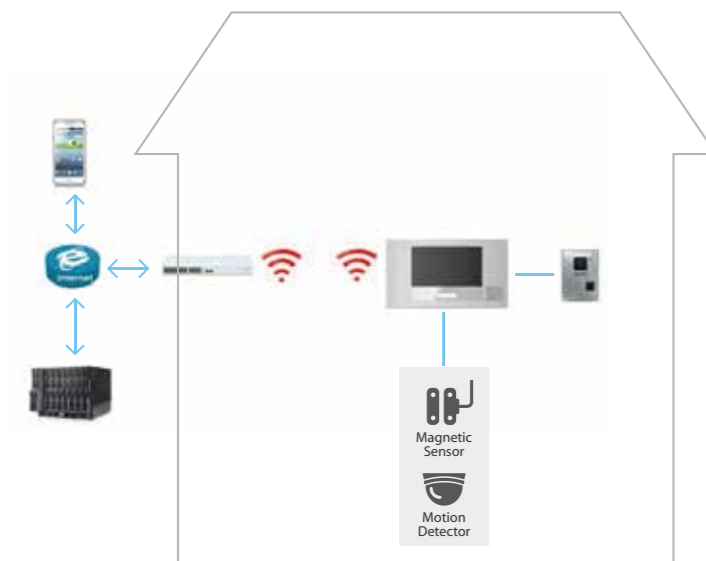

Connecting Diagram

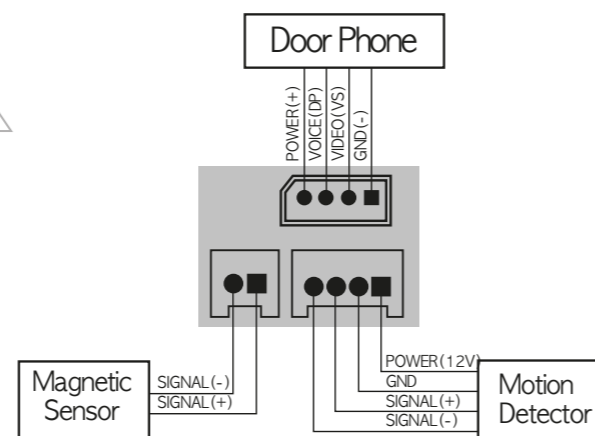

NAVIENT VIDEO PHONE



Recommended Products



Door Camera
UDP-300



Door Camera
UDP-400



Door Camera
UDP-500 Series



Door Camera
UDP-600 Series



Interphone
UIP-200



Door Camera
UDP-735

UHA-770

7"(17.8cm) Video Phone (For both Master and Slave)
2 Cameras + 2 Monitors + 1 Interphone

FEATURES & BENEFITS

- User friendly interface & Touch screen
- Call and Talk to visitor, Door release
- Intercom Function
- Security functions with Magnetic Sensor
- Still or Video recordable (Option – Micro SD)

Specifications

POWER SOURCE	100-240V AC , 50-60Hz (+14V DC, 1.5A - Optional)
COLOR	WHITE
DISPLAY	7 inch(17.8cm) TFT Color LCD (NTSC/PAL Convertible)
COMMUNICATION	Hands free
MOUNT TYPE	Wall surface mounted type
WIRING	1) Door Camera : 4 wires (polarity) 2) Intercom : 2 wires (polarity) 3) Interphone 4 wires (polarity)
DISTANCE	1) To Door Camera : 28m(TIV Ø0.5), 50m(TIV Ø0.65), 70m(TIV Ø0.8) (Up to the last Video Phone) 2) To Intercom, Interphone : 20m(TIV Ø0.5)
DIMENSIONS	288.5(W) X 170(H) X 29(D) mm

System Diagram

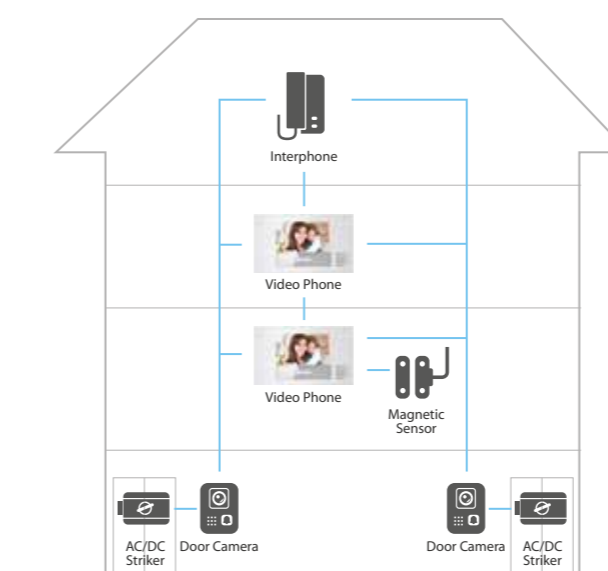

Connecting Diagram

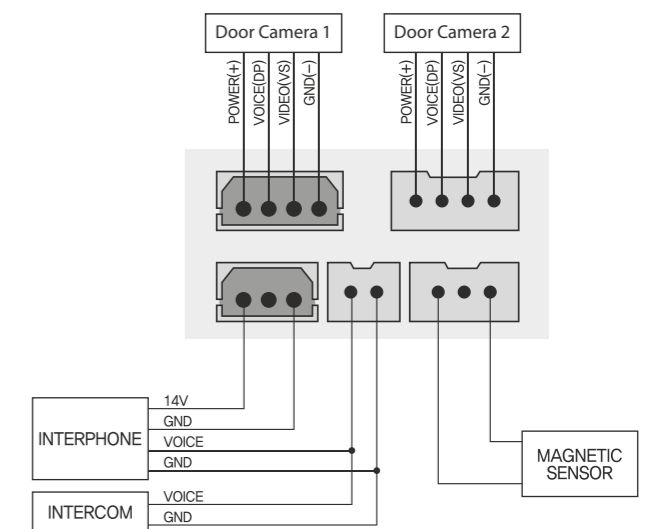



White

Black

Recommended Products



Door Camera UDP-300 Door Camera UDP-400 Door Camera UDP-500 Series Door Camera UDP-600 Series

Door Camera UDP-735

UHA-742

7"(17.8cm) Video Phone (For both Master and Slave)
2 Cameras + 4 Monitors

FEATURES & BENEFITS

- Call and Talk to visitor, Door release
- Intercom Function (All Paging, Appointed Intercom)
- EMO LED Touch Buttons
- Still or Video recordable (Option)

Specifications

POWER SOURCE	100-240V AC , 50-60Hz
COLOR	WHITE / BLACK (Optional)
DISPLAY	7 inch(17.8cm) TFT Color LCD (NTSC/PAL Convertible)
COMMUNICATION	Hands free
MOUNT TYPE	Wall surface mounted type
WIRING	1) Door Camera : 4 wires (Polarity) 2) Intercom : 8 wires (Polarity)
DISTANCE	To Door Camera : 28m(TIV Φ0.5), 50m(TIV Φ0.65), 70m(TIV Φ0.8) (Up to the last Video Phone)
DIMENSIONS	254.5(W) X 135.5(H) X 32.0(D) mm

System Diagram

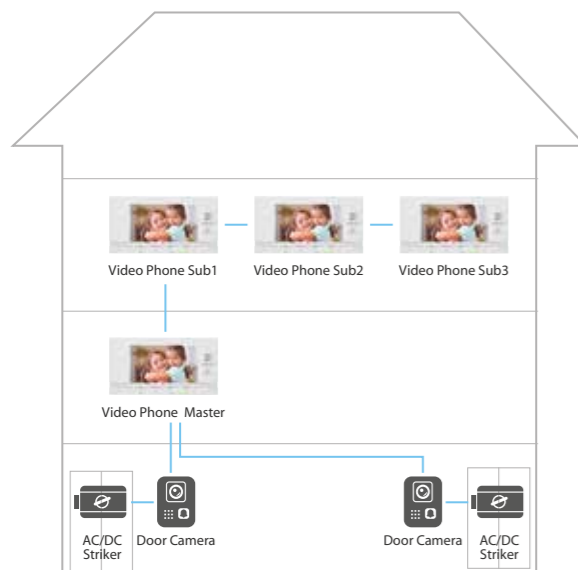

Connecting Diagram

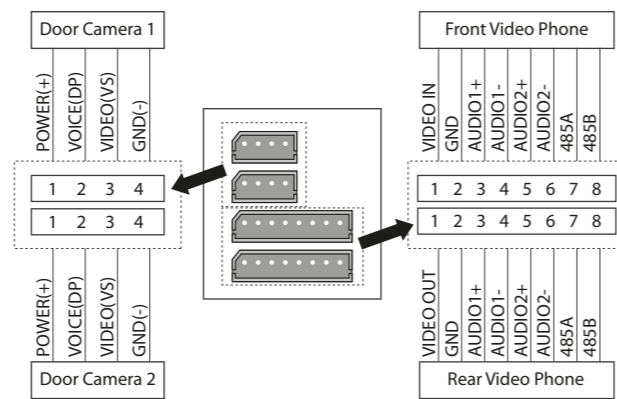

Recommended Products



Door Camera UDP-300 Door Camera UDP-400 Door Camera UDP-500 Series

Door Camera UDP-600 Series Interphone UIP-200 Door Camera UDP-735

UHA-732

7"(17.8cm) Handset Video Phone (For both Master and Slave)
2 Cameras + 2 Monitors + 1 Interphone

FEATURES & BENEFITS

- Call and Talk to visitor, Door release
- Intercom Function
- Still or Video recordable (Option – Micro SD)

Specifications

POWER SOURCE	100-240V AC , 50-60Hz (+14V DC, 1.5A - Optional)
COLOR	WHITE
DISPLAY	7 inch(17.8cm) TFT Color LCD (NTSC/PAL Convertible)
COMMUNICATION	Handset, Duplex
MOUNT TYPE	Wall surface mounted type
WIRING	1) Door Camera : 4 wires (polarity) 2) Intercom : 2 wires (polarity) 3) Interphone 4 wires (polarity)
DISTANCE	1) To Door Camera : 28m(TIV Φ0.5), 50m(TIV Φ0.65), 70m(TIV Φ0.8) (Up to the last Video Phone) 2) To Intercom, Interphone : 20m(TIV Φ0.5)
DIMENSIONS	320(W) X 157(H) X 28.5(D) mm

System Diagram

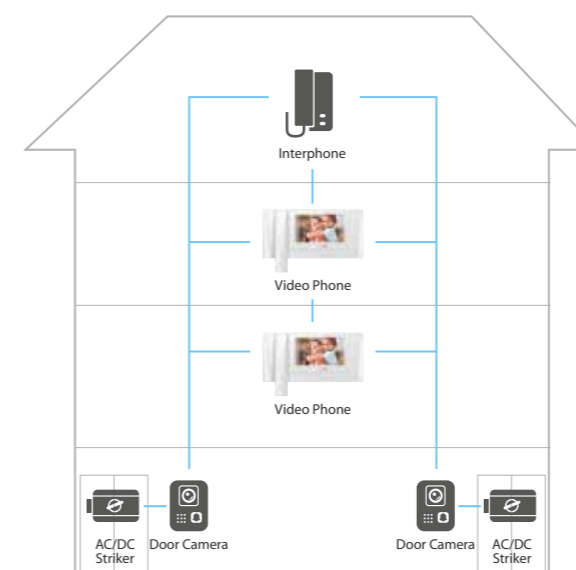

Connecting Diagram

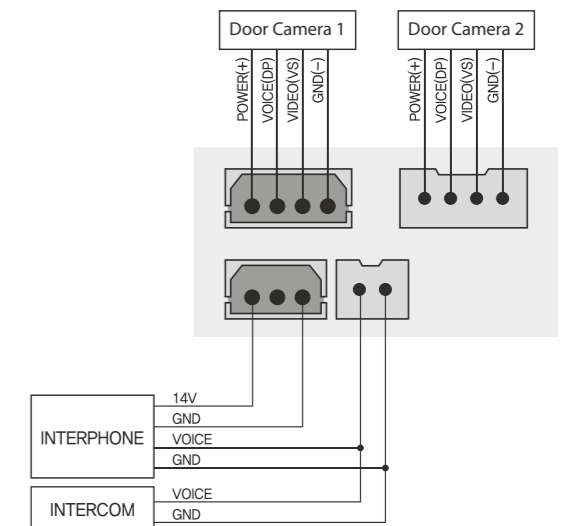



Recommended Products



Door Camera
UDP-715

UHA-471

4"(10.1cm) Video Phone
Easy to install two wire system
1 Camera + 2 Monitors

FEATURES & BENEFITS

- Call and Talk to visitor, Door release
- AC/DC Door striker compatible
- LED Back Light
- OSD (On Screen Display)
- Standby Power reducing product

Specifications

POWER SOURCE	100-240V AC , 50-60Hz (+14V DC, 1.5A - Optional)
COLOR	WHITE
DISPLAY	4"(10.1cm) TFT Color LCD(NTSC/PAL Convertible)
COMMUNICATION	Hands free
MOUNT TYPE	Wall surface mounted type
WIRING	1) Door Camera : 2 Wires(Non Polarity) 2) Extra Video Phone : 2 Wires(Polarity)
DISTANCE	To Door Camera : 28m(TIV Φ0.5), 50m(TIV Φ0.65), 70m(TIV Φ0.8) (Up to the last Video Phone)
DIMENSIONS	274(W) X 188(H) X 11(D)

System Diagram

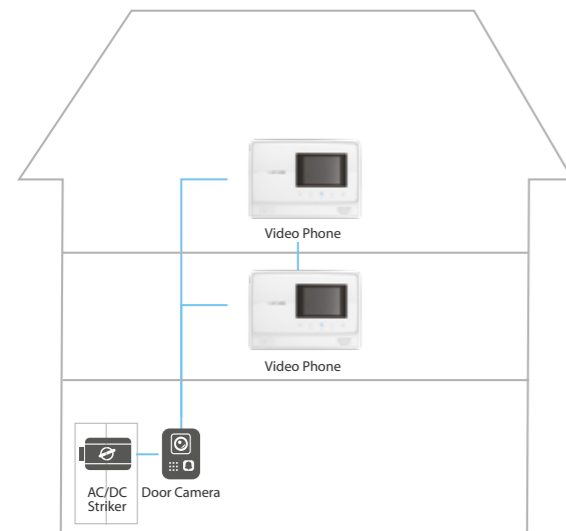

Connecting Diagram (Rear View)

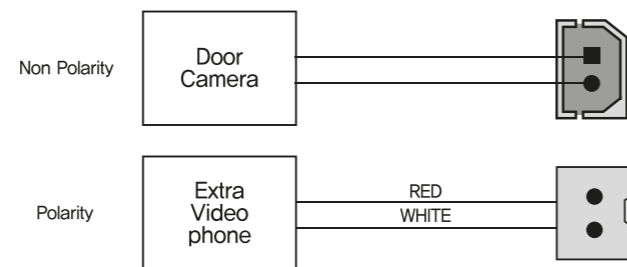

Recommended Products



Door Camera
UDP-300



Door Camera
UDP-400



Door Camera
UDP-500 Series



Door Camera
UDP-600 Series



Door Camera
UDP-735

UHA-422

4"(10.2cm) Video Phone (For both Master and Slave)
2 Cameras + 4 Monitors

FEATURES & BENEFITS

- Call and Talk to visitor, Door release
- Intercom Function
- Still or Video recordable (Option)

Specifications

POWER SOURCE	100-240V AC , 50-60Hz
COLOR	WHITE / BLACK (Optional)
DISPLAY	4 inch(10.2cm) TFT Color LCD (NTSC/PAL Convertible)
COMMUNICATION	Hands free
MOUNT TYPE	Wall surface mounted type
WIRING	1) Door Camera : 4 wires (Polarity) 2) Intercom : 2 wires (Polarity)
DISTANCE	1) To Door Camera : 28m(TIV Φ0.5), 50m(TIV Φ0.65), 70m(TIV Φ0.8) (Up to the last Video Phone) 2) To Intercom : 20m(TIV Φ0.5)
DIMENSIONS	202(W) X 142(H) X 32(D) mm

System Diagram

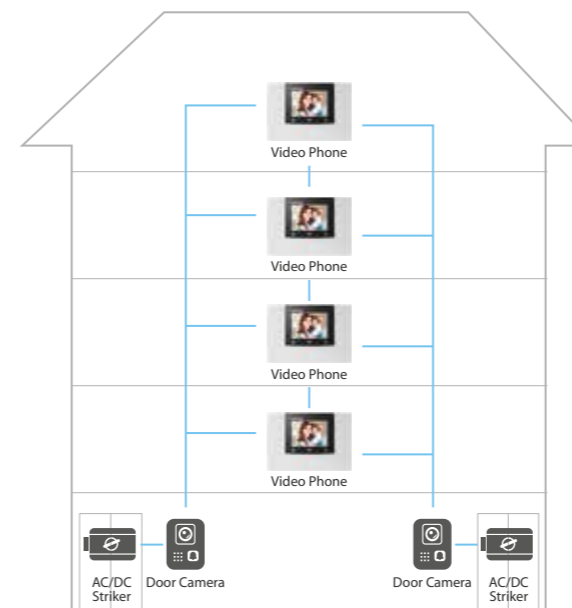



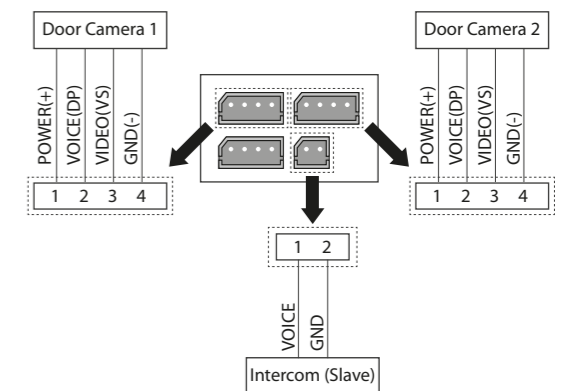

Connecting Diagram



NAVIENT VIDEO PHONE



Recommended Products

Door Camera UDP-300 Door Camera UDP-400 Door Camera UDP-500 Series Door Camera UDP-600 Series

Door Camera UDP-735

UHA-472

4"(10.1cm) Videophone 1 Camera + 1 Monitor

FEATURES & BENEFITS

- Call and Talk to visitor, Door release
- Intercom Function

Specifications

POWER SOURCE	100-240V AC , 50-60Hz
COLOR	WHITE / BLACK (Optional)
DISPLAY	4 inch(10.2cm) TFT Color LCD (NTSC/PAL Convertible)
COMMUNICATION	Hands free
MOUNT TYPE	Wall surface mounted type
WIRING	1) Door Camera : 4 wires (Polarity) 2) GUARD : 2 wires(Polarity)
DISTANCE	1) To Door Camera : 28m(TIV Ø0.5), 50m(TIV Ø0.65), 70m(TIV Ø0.8) (Up to the last Video Phone) 2) To GUARD : 20m(TIV Ø0.5)
DIMENSIONS	274(W) X 188(H) X 11(D) mm

System Diagram

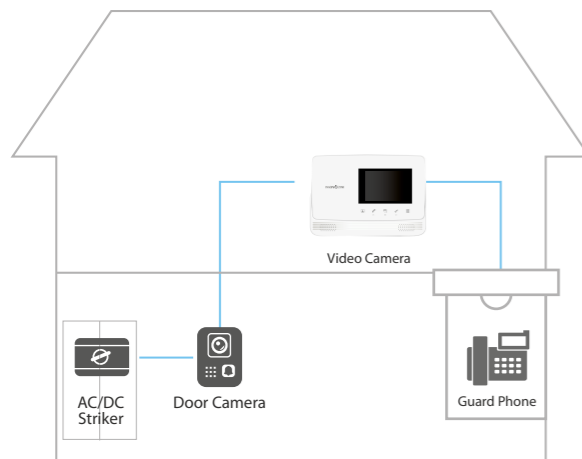



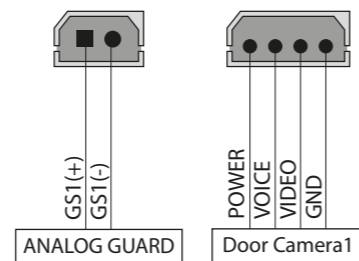

Connecting Diagram



NAVIENT DIGITAL APT VIDEO PHONE



Recommended Products

Door Camera UDP-300N Lobby Phone ULP-201 Lobby Phone ULP-320

Lobby Phone ULP-420

UHA-474

4"(10.1cm) Digital Videophone

FEATURES & BENEFITS

- Call and Talk to visitor, Door release, Detour call to another flat Via Guard Phone
- Call and Talk to Guard Phone

Specifications

POWER SOURCE	100-240V AC , 50-60Hz
COLOR	WHITE / BLACK (Optional)
DISPLAY	4 inch(10.2cm) TFT Color LCD (NTSC/PAL Convertible)
COMMUNICATION	Hands free
MOUNT TYPE	Wall surface mounted type
WIRING	1) Door Camera : 4 wires (Polarity) 2) Lobby Phone : 6 wires (Polarity)
DISTANCE	To Door Camera : 28m(TIV Ø0.5), 50m(TIV Ø0.65), 70m(TIV Ø0.8)
DIMENSIONS	274(W) X 188(H) X 11(D) mm

System Diagram

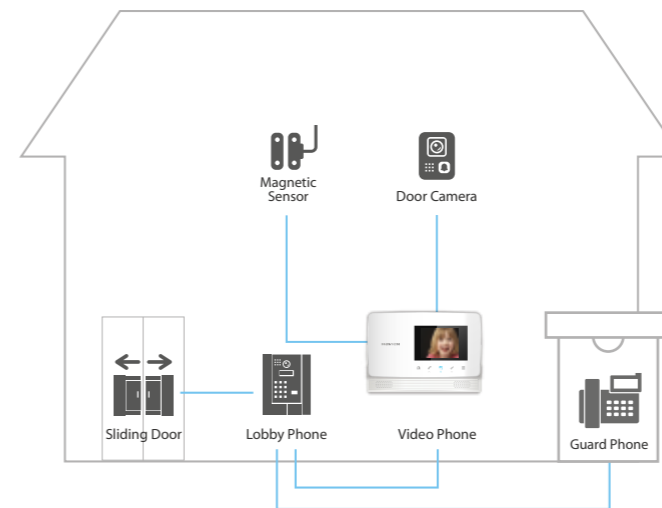

Connecting Diagram

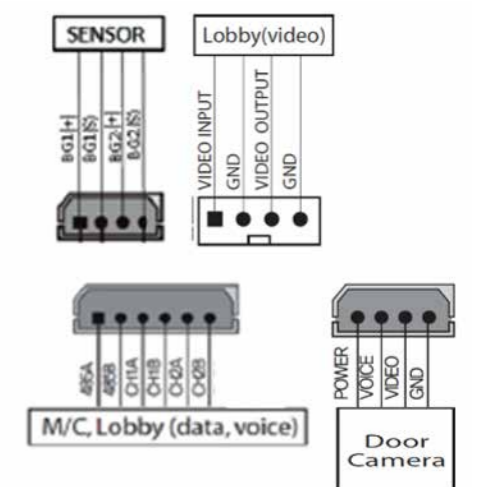



White

Black

Recommended Products

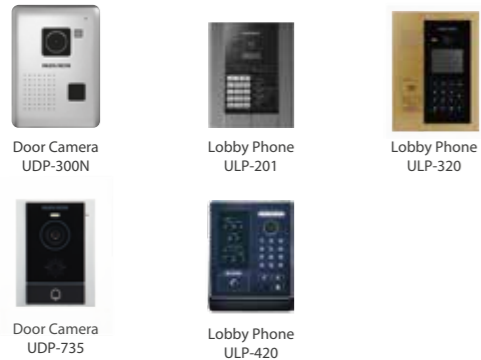

Door Camera UDP-300N Lobby Phone ULP-201 Lobby Phone ULP-320

Door Camera UDP-735 Lobby Phone ULP-420

UHA-454

4"(10.2cm) Digital APT Video Phone

FEATURES & BENEFITS

- Call and Talk to visitor, Door release, Detour call to another flat Via Guard Phone
- Call and Talk to Guard Phone
- AC/DC Door striker compatible



Specifications

POWER SOURCE	100-240V AC , 50-60Hz
COLOR	WHITE / BLACK (Optional)
DISPLAY	4 inch(10.2cm) TFT Color LCD (NTSC/PAL Convertible)
COMMUNICATION	Hands free
MOUNT TYPE	Wall surface mounted type
WIRING	1) Door Camera : 4 wires (Polarity) 2) Lobby Phone : 6 wires (Polarity)
DISTANCE	To Door Camera : 28m(TIV Ø0.5), 50m(TIV Ø0.65), 70m(TIV Ø0.8)
DIMENSIONS	202(W) X 142(H) X 32(D) mm

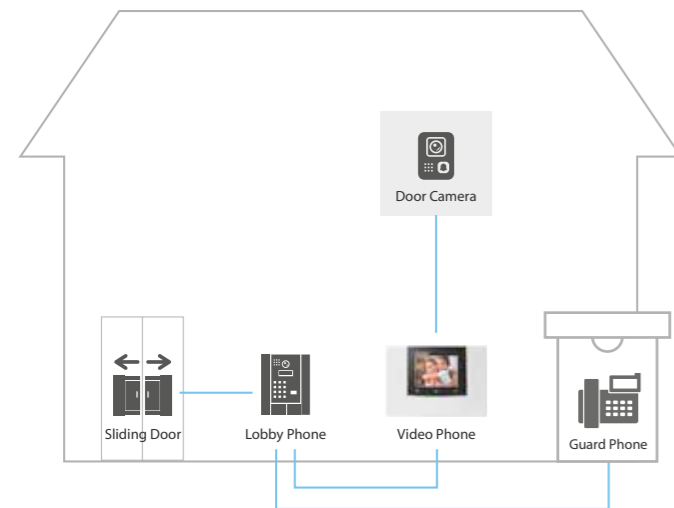
System Diagram

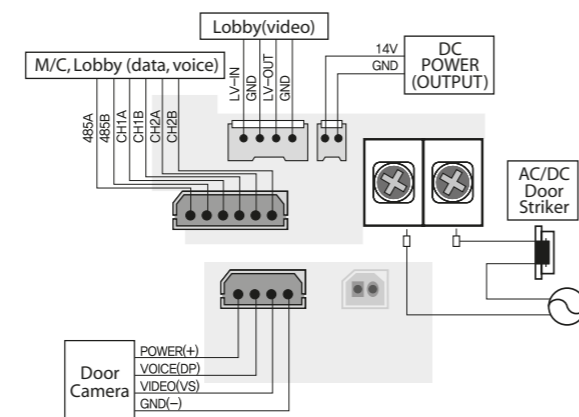

Connecting Diagram

Recommended Products



Door Camera UDP-300 Door Camera UDP-400 Door Camera UDP-500 Series

Door Camera UDP-600 Series Interphone UIP-200 Door Camera UDP-735

UHA-432

4"(10.2cm) Handset Video Phone
(For both Master and Slave)
2 Cameras + 2 Monitors + 1 Interphone

FEATURES & BENEFITS

- Call and Talk to visitor, Door release
- Intercom Function
- Still or Video recordable (Option)

Specifications

POWER SOURCE	100-240V AC , 50-60Hz
COLOR	WHITE
DISPLAY	4 inch(10.2cm) TFT Color LCD (NTSC/PAL Convertible)
COMMUNICATION	Handset, Duplex
MOUNT TYPE	Wall surface mounted type
WIRING	1) Door Camera : 4 wires (polarity) 2) Intercom : 2 wires (polarity) 3) Interphone 4 wires (polarity)
DISTANCE	1) To Door Camera : 28m(TIV Ø0.5), 50m(TIV Ø0.65), 70m(TIV Ø0.8) (Up to the last Video Phone) 2) To Intercom, Interphone : 20m(TIV Ø0.5)
DIMENSIONS	170(W) X 206(H) X 35(D) mm

System Diagram

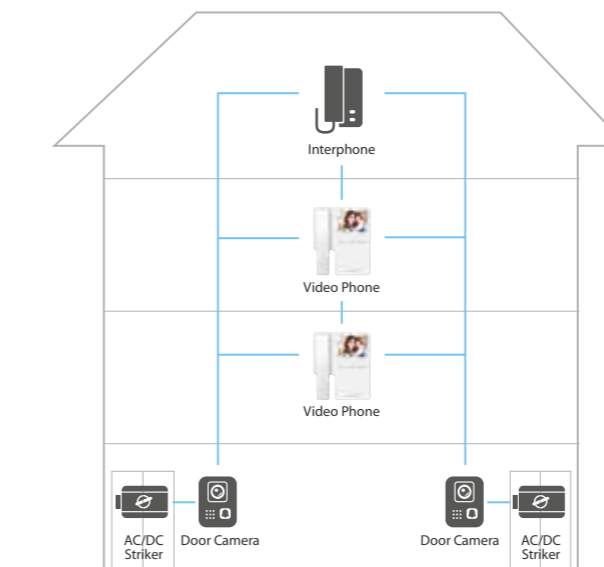

Connecting Diagram

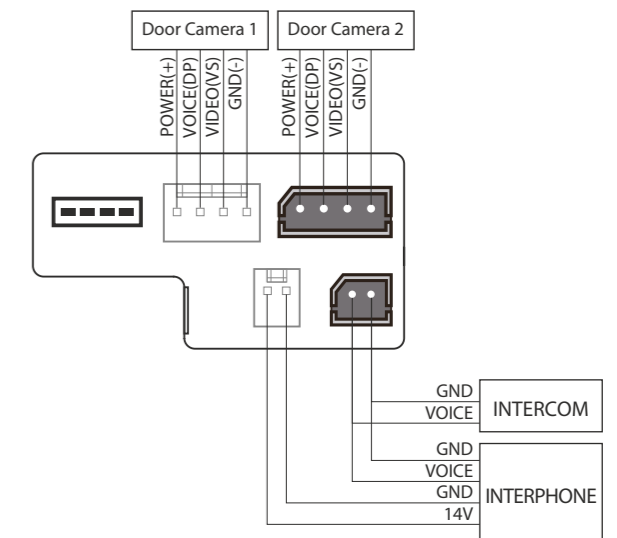

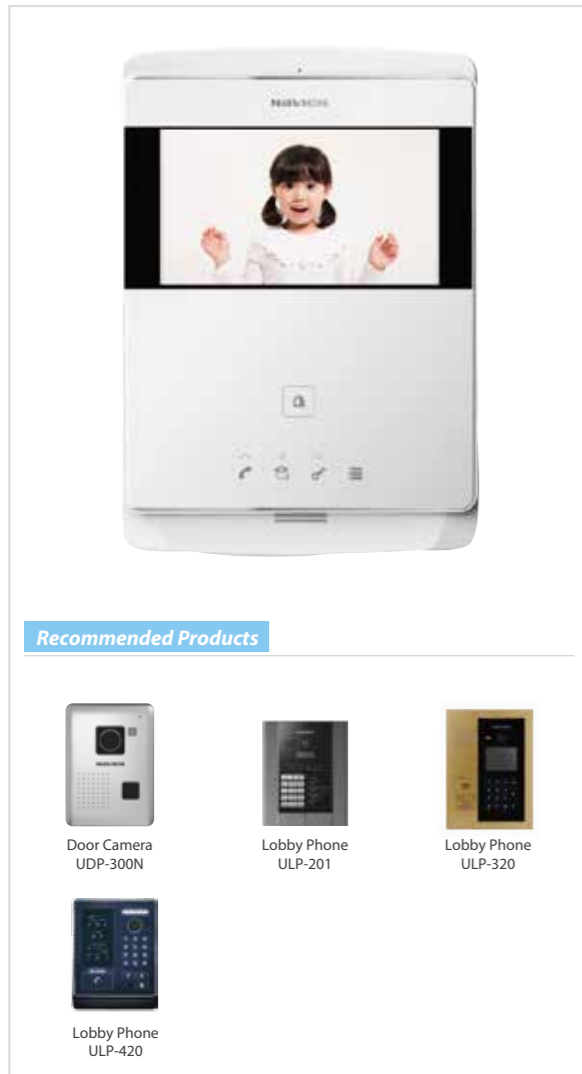

UHA-784

7"(17.8cm) Digital Video Phone

FEATURES & BENEFITS

- Call and Talk to visitor, Door release, Detour call to another flat Via Guard Phone
- Call and Talk to Guard Phone
- Security functions with Magnetic Sensor

Specifications

POWER SOURCE	100-240V AC , 50-60Hz
COLOR	WHITE
DISPLAY	7 inch(17.8cm) TFT Color LCD(NTSC/PAL Convertible)
COMMUNICATION	Hands free
MOUNT TYPE	Wall surface mounted type/Wall flush mounted type
WIRING	1) Door Camera : 4 wires (Polarity) 2) Lobby Phone : 6 wires (Polarity)
DISTANCE	To Door Camera : 28m(TIV Φ0.5), 50m(TIV Φ0.65), 70m(TIV Φ0.8)
DIMENSIONS	194.5(W) X 254.8(H) X 30(D) mm

Recommended Products

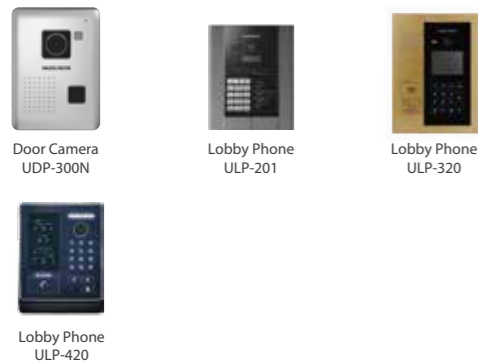

System Diagram

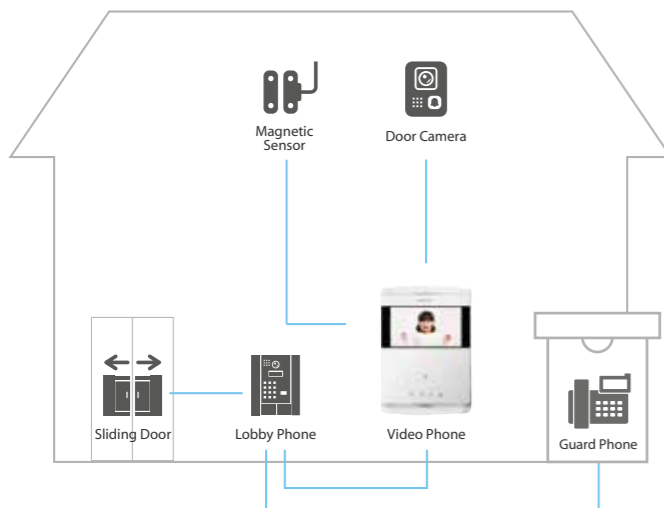

Connecting Diagram

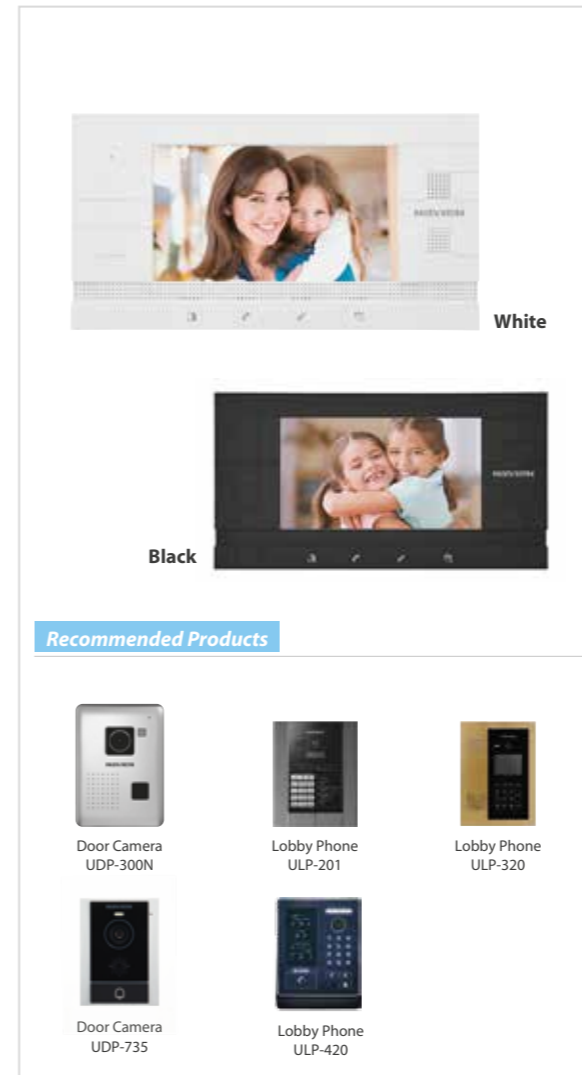
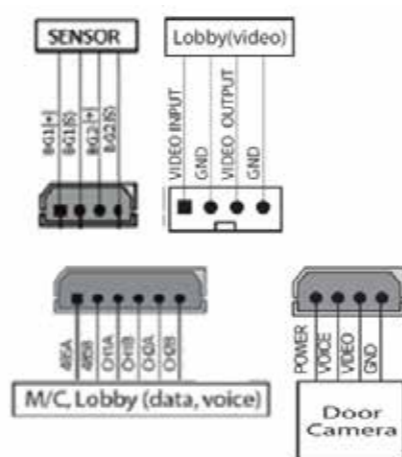

UHA-744

7"(17.8cm) Digital APT Video Phone

FEATURES & BENEFITS

- Call and Talk to visitor, Door release, Detour call to another flat Via Guard Phone
- Call and Talk to Guard Phone
- Security functions with Magnetic Sensor
- AC/DC Door striker compatible
- EMO LED Touch Buttons
- Still or Video recordable (Option)

Specifications

POWER SOURCE	100-240V AC , 50-60Hz
COLOR	WHITE / BLACK (Optional)
DISPLAY	4 inch(10.2cm) TFT Color LCD (NTSC/PAL Convertible)
COMMUNICATION	Hands free
MOUNT TYPE	Wall surface mounted type
WIRING	1) Door Camera : 4 wires (Polarity) 2) Lobby Phone : 8 wires (Polarity)
DISTANCE	1) To Door Camera : 28m(TIV Φ0.5), 50m(TIV Φ0.65), 70m(TIV Φ0.8) 2) To Lobby Phone : UTP 4P(8c)
DIMENSIONS	254.5(W) X 135.5(H) X 32.0(D) mm

Recommended Products



System Diagram

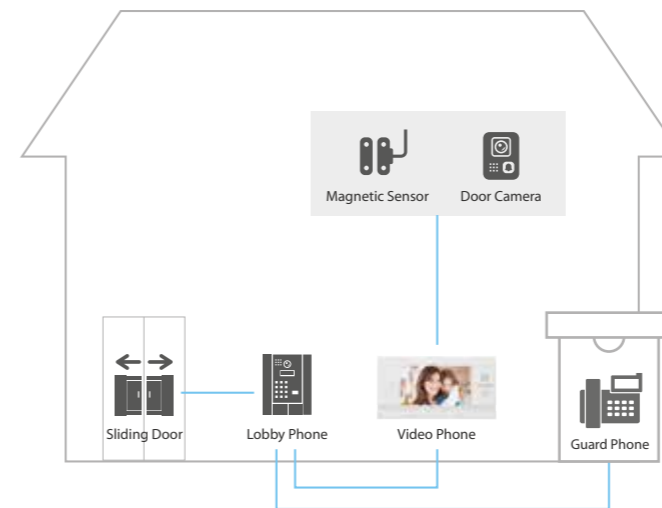

Connecting Diagram

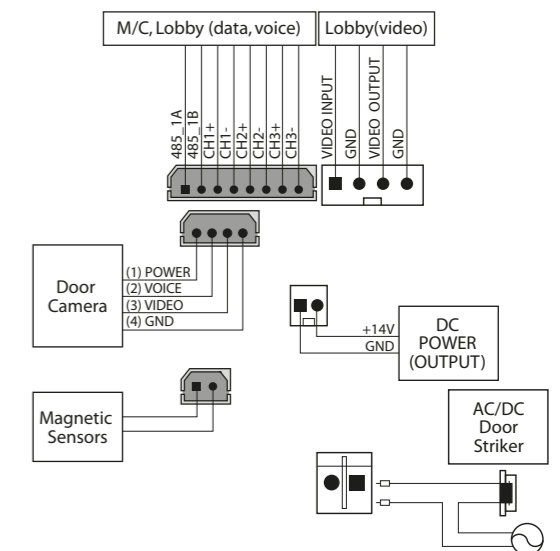



*Security and
Communication*

NAVIEN sleek and robust door panels offer the durability and reliability.



UDP-300/300N/305

Door Camera

FEATURES & BENEFITS

- Visual check visitors
- Call and talk to flats
- White LED at night
- Aluminum die-casting cover

Recommended Products

UDP-300/305

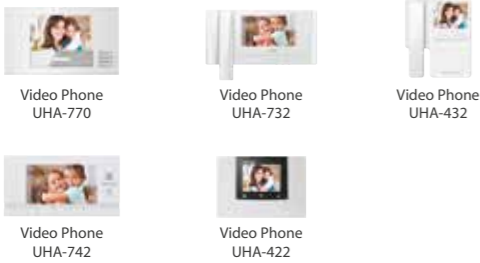

UDP-300N

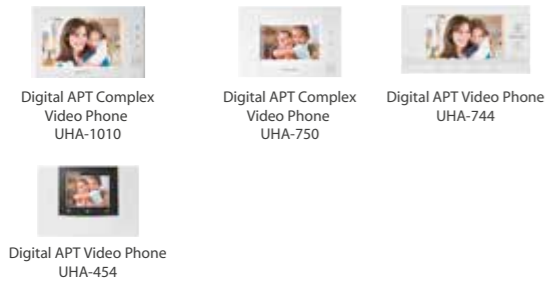

Specifications

POWER SOURCE	+14V DC (from monitor)	
COLOR	WHITE/SILVER/BLACK	
SENSOR TYPE	CMOS image sensor	
VIDEO SIGNAL	1Vp-p/75Ω, Composite	
MINIMUM ILLUMINATION	0.1 Lux (300mm from Camera)	
LED	Embedded white LED	
EFFECTIVE VIEWING ANGLE	Diagonal 73°	
MOUNT TYPE	UDP-300/300N	Wall surface mounted type
	UDP-305	Wall flush mounted type
WIRING	4 wires (Polarity) to a monitor	
DISTANCE	Max 50m(TIV Ø0.65) (Up to the last Video Phone)	
	UDP-300/300N	93(W)X130(H)X29.5(D)
UDP-305	99(W)X140(H)X11.5(D)	

Connecting Diagram

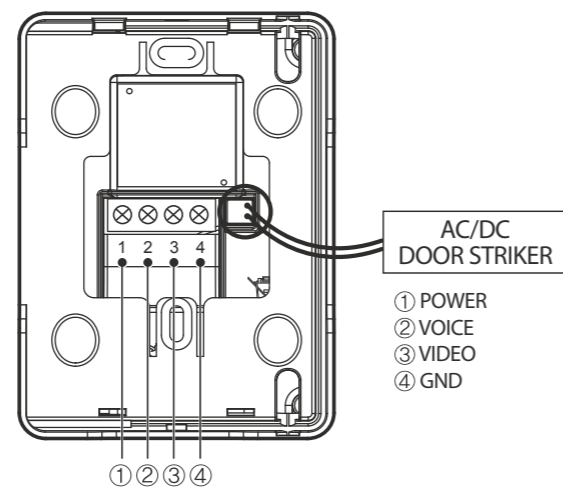

UDP-400

Pinhole Lens Type Door Camera

FEATURES & BENEFITS

- 3.7mm Flat Pinhole lens
- Visual check visitors
- Call and talk to flats
- IR LED at night
- Full Metal body armour

Specifications

POWER SOURCE	+14V DC (from monitor)
COLOR	SILVER
SENSOR TYPE	CMOS image sensor
VIDEO SIGNAL	1Vp-p/75Ω, Composite
MINIMUM ILLUMINATION	0.1 Lux (300mm, Day & Night)
LED	Infrared LED 3EA
EFFECTIVE VIEWING ANGLE	Diagonal 73°
MOUNT TYPE	Wall surface mounted type
DOOR SIGNAL	MAX DC +30V, 1A
WIRING	4 wires (Polarity) to a monitor
DISTANCE	Max 50m(TIV Ø0.65) (Up to the last Video Phone)
DIMENSIONS	40(W) x 120(H) x 21(D) mm

Recommended Products

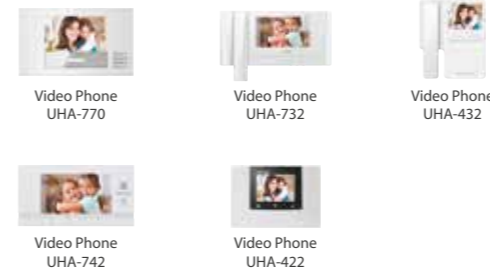

Connecting Diagram

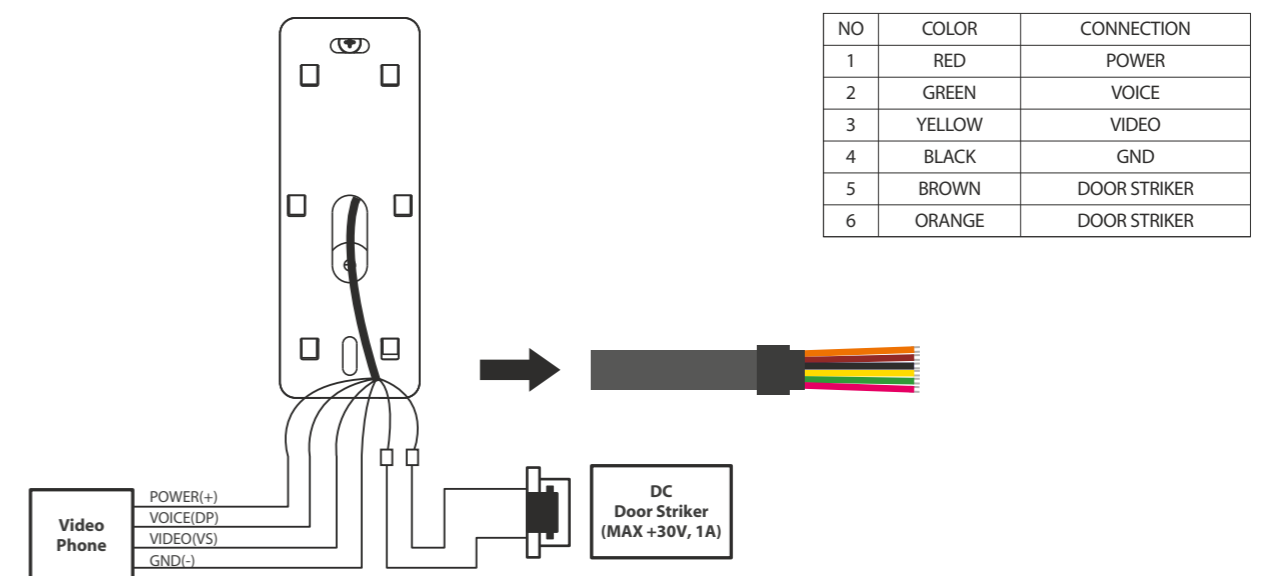



UDP-500 Series

Multi Button Door Camera

FEATURES & BENEFITS

- Visual check visitors
- Call and talk to flats
- White LED at night
- Support Max. 40 flats

Specifications

POWER SOURCE	UDP-510	+12V DC, 500mA
	UDP-510 & UDP-520	+12V DC, 700mA
	UDP-510 & UDP-530	+12V DC, 900mA
	UDP-510 & UDP-540	+12V DC, 1.1A
COLOR	SILVER	
SENSOR TYPE	CMOS image sensor (COLOR)	
VIDEO SIGNAL	1Vp-p/75Ω, Composite	
LED	For Night Vision	White Led 4EA
	For Name Panel	Green LED 2 ~ 40EA
EFFECTIVE VIEWING ANGLE	Diagonal 73°	
MOUNT TYPE	Wall Flush-mounted type	
DOOR RELEASE	AC/DC DOOR STRIKER	
WIRING	Up to 40 Video Phone each : 4 wires in Polarity	
DISTANCE	Max 50m(TIV Ø0.65) (Up to the farthest Video Phone)	
DIMENSIONS	129(W) X 336(H) X 20(D) mm	

Recommended Products

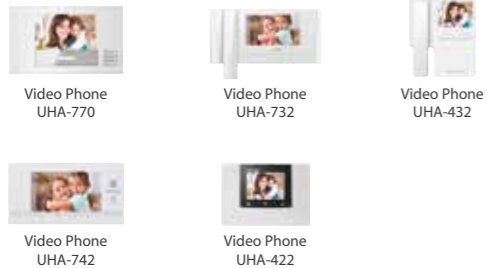

Product Line-up

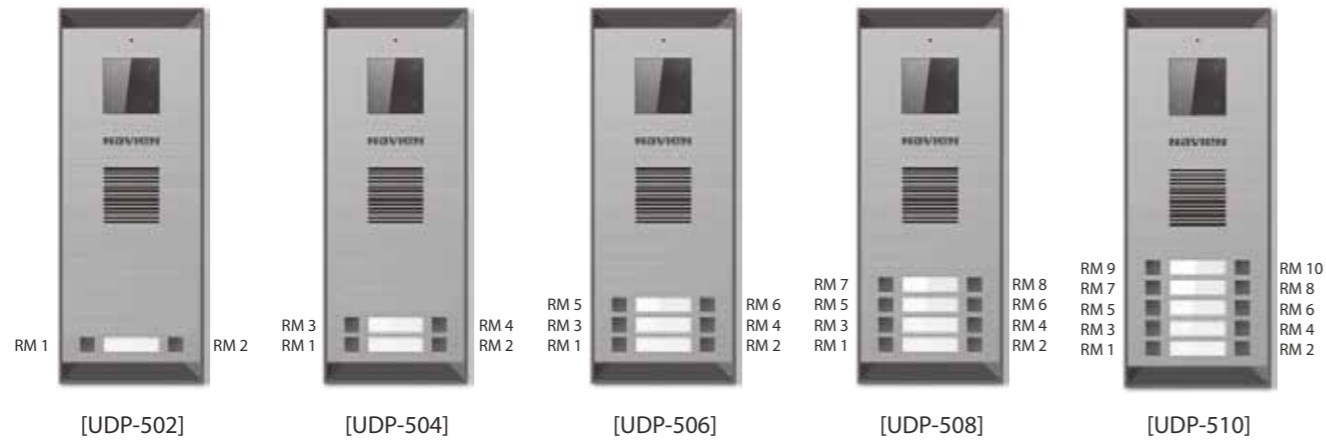

Extensional Application

20 APT / VILLAS

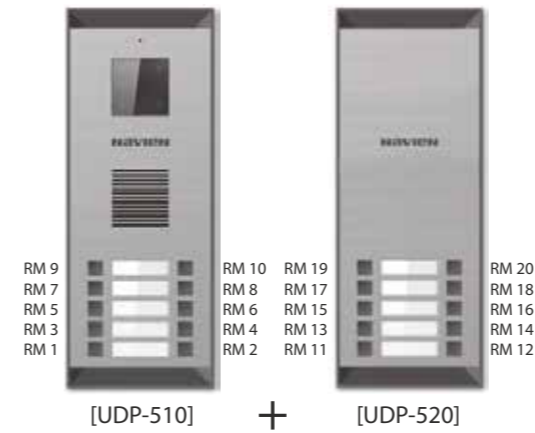

30 APT / VILLAS

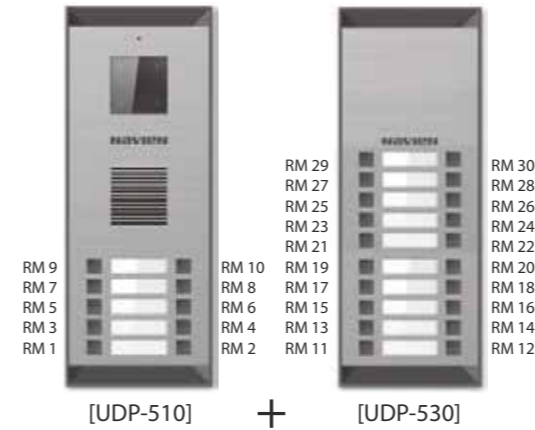

40 APT / VILLAS

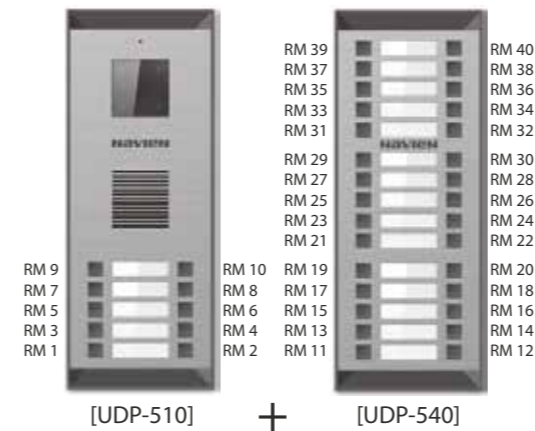

Connecting Diagram (Rear View)

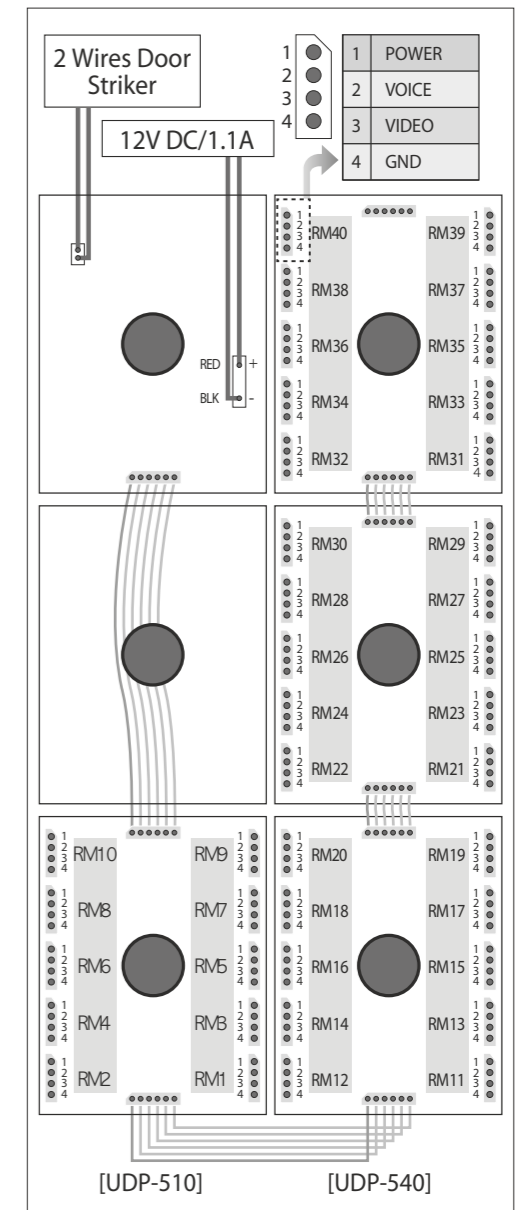

NAVIENT DOOR CAMERA



Recommended Products



Video Phone
UHA-770



Video Phone
UHA-732



Video Phone
UHA-432



Video Phone
UHA-742



Video Phone
UHA-422

UDP-600 Series

Multi Button Door Camera

FEATURES & BENEFITS

- Visual check visitors
- Call and talk to flats
- White LED at night (UDP-601~614)
- IR LED at night (UDP-620)
- Support Max 4 flats

Specifications

POWER SOURCE	+14V DC (from monitor)	
COLOR	METALLIC SILVER	
SENSOR TYPE	CMOS image sensor (COLOR)	
VIDEO SIGNAL	1Vp-p/75Ω, Composite	
MINIMUM ILLUMINATION	0.1 Lux (300mm from Camera)	
LED	UDP-601~604 / UDP-611~614	White LED 3EA
	UDP-620	IR LED 2EA
EFFECTIVE VIEWING ANGLE	UDP-601~604 / UDP-611~614	Diagonal 73°
	UDP-620	Diagonal 120°
MOUNT TYPE	UDP-601~604	Wall surface mounted type
	UDP-611~614 / UDP-620	Wall Flush-mounted type
DOOR RELEASE	AC/DC DOOR STRIKER	
WIRING	4 wires (Polarity) to a monitor	
DISTANCE	Max 50m(TIV Ø0.65) (Up to the farthest Video Phone)	
DIMENSIONS	UDP-601~604	113(W) x 183(H) x 39.5(D) mm
	UDP-611~614 / UDP-620	113(W) x 183(H) x 15(D) mm

Product Line-up

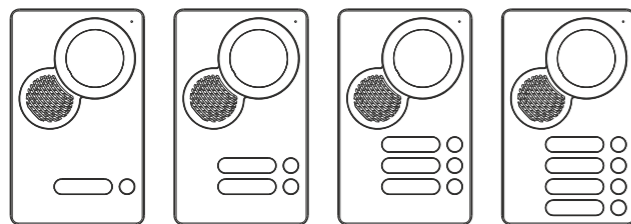

MODEL	UDP - 601 UDP - 611 UDP - 620	UDP - 602 UDP - 612	UDP - 603 UDP - 613	UDP - 604 UDP - 614
Button	-	-	3rd. (RM #3)	4th. (RM #4)
	-	2nd. (RM #2)	2nd. (RM #2)	3rd. (RM #3)
	1 st. (RM #1)	1st. (RM #1)	1st. (RM #1)	2nd. (RM #2)
	-	-	-	1st. (RM #1)

* UDP-601~604 : SURFACE BRACKET Type
 * UDP-611~614 : FLUSH MOUNT Type
 * UDP-620 : FLUSH MOUNT Type

Connecting Diagram (Rear View)

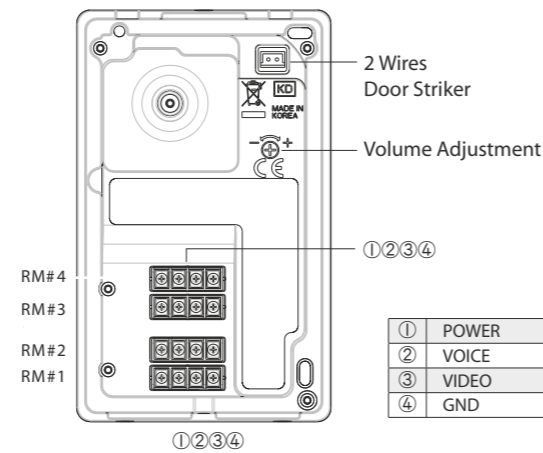

* WIRING (EX. UDP-604/614)

①	POWER
②	VOICE
③	VIDEO
④	GND

NAVIENT DOOR CAMERA



Recommended Products

UDP-715



Video Phone
UHA-471

UDP-735



Video Phone
UHA-770



Video Phone
UHA-732



Video Phone
UHA-432



Video Phone
UHA-742



Video Phone
UHA-422

UDP-715/735

Door Camera

FEATURES & BENEFITS

- Visual check visitors
- Call and talk to flats
- White LED at night

Specifications

Model	UDP-715	UDP-735
POWER SOURCE	12V~14V DC from videophone	
Video output	1Vp-p/75Ω, Composite	
Camera module	1/4" Color CMOS	
Viewing Angle	Diagonal 82.5° degrees	
Illumination	0.1 Lux (600mm from camera)	
Operational Environment	Temperature	-10°C ~ 50°C
	Humidity	Less than 90% (Relative humidity)
Appearance	Dimensions	150(W) X 110(H) X 33(D)
	Weight	Approximately 205g / Approximately 195g
Installation method	Surface mount	
Door opening	AC/DC Door striker	
Wiring	Distance	50 meters(0.65Φ),meters(0.5Φ)
	Method	2 wires, Non-polarity / 4 wires, Polarity
Compatible videophone	UHA-471SG	4 wires videophone

Components

■ REAR VIEW

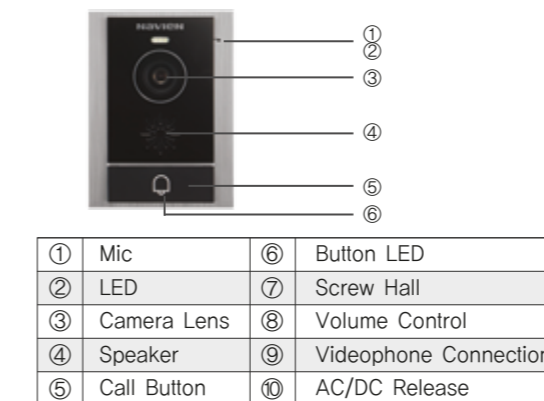

Wiring Diagram

■ REAR VIEW

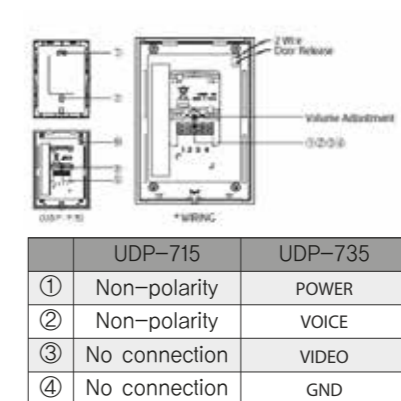



*Communication, concierge and
security in a single system*

NAVIEN has focused on realizing continuous improvement.

White Pearl
Champagne Pearl
Blue Black Pearl

Recommended Products

Digital APT Video Phone UHA-744
Digital APT Video Phone UHA-454
Guard Phone UGP-100

ULP-420/420R

Lobby Phone

FEATURES & BENEFITS

- 7" (17.8cm) TFT Color LCD display
- User focused GUI for Convenience
- Call and Talk to flats
- Call and Talk to Guard Phone
- Adjusting camera angle
- Door open by common password
- Door open with RF ID Card (Optional)
- Built in Controller (for 127 flats Max.)
- Dial Back Light

Specifications

POWER SOURCE	+12V DC, 2.5A
COLOR	White Pearl, Champagne Gold Pearl, Blue Black Pearl
MOUNT TYPE	Wall Flush-mounted
DATA COMMUNICATION	RS-485
DIMENSIONS	226(W) X 296(H) X 21.8(D)
FLUSH BRACKET	262(W) X 350(H) X 100(D)

Recommended Products

Digital APT Video Phone UHA-744
Digital APT Video Phone UHA-454
Guard Phone UGP-100

ULP-201

Lobby Phone

FEATURES & BENEFITS

- Call and Talk to flats
- Call and Talk to Guard Phone
- FND Display
- Aluminum die-casting
- Adjusting camera angle
- Door open by common password
- Built in Controller (for 127 flats Max.)

Specifications

POWER SOURCE	+12V DC, 2.5A
COLOR	SILVER
MOUNT TYPE	Wall Flush-mounted type
DATA COMMUNICATION	RS-485
DIMENSIONS	230(W) X 280(H) X 39(D) mm
FLUSH BRACKET	221(W) x 256(H) x 92(D) mm

System Diagram

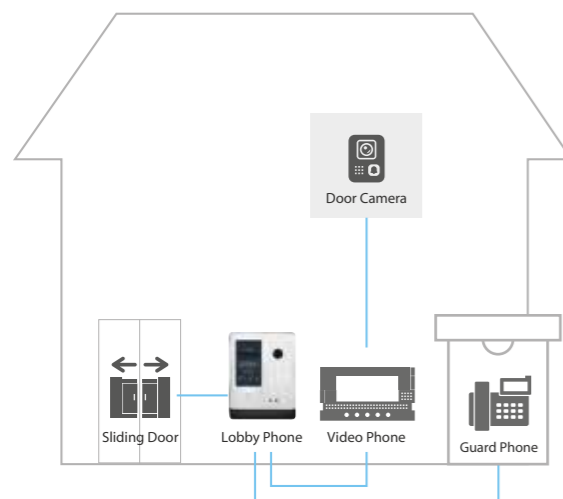

Connecting Diagram

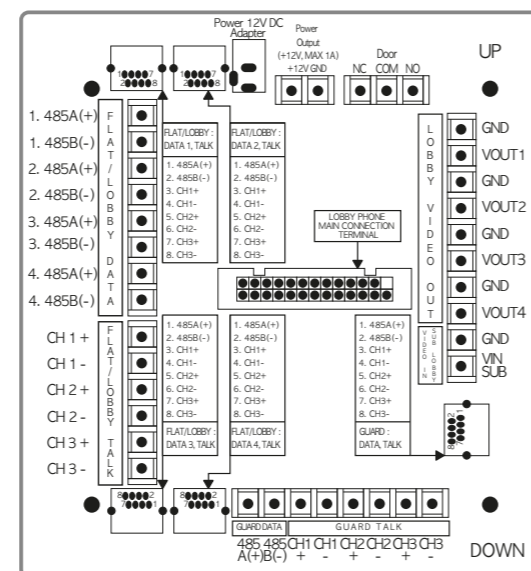

System Diagram

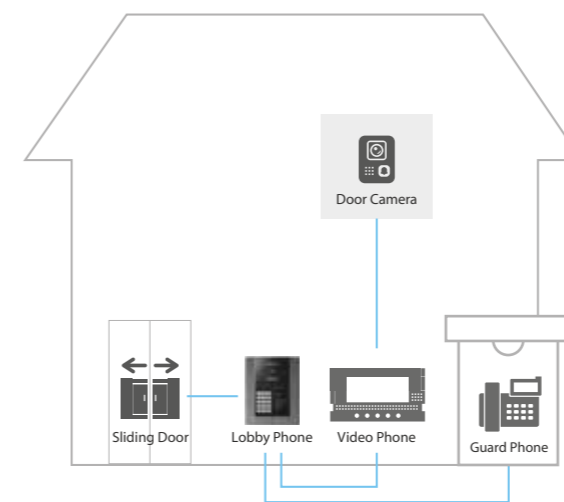

Connecting Diagram(Terminal Board)

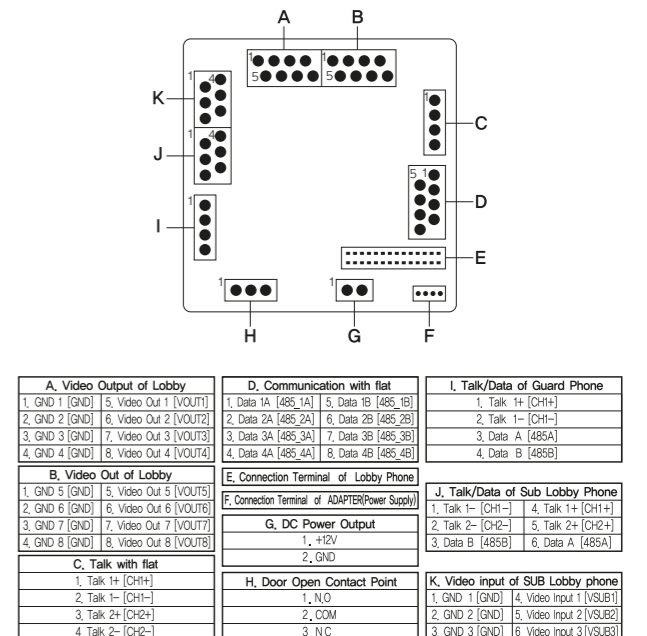



ULP-320

ULP-320R

Recommended Products



Digital APT Video Phone UHA-744



Digital APT Video Phone UHA-454



Guard Phone UGP-100

ULP-320/320R

Lobby Phone

FEATURES & BENEFITS

- Call and Talk to flats
- Call and Talk to Guard Phone
- LCD Display
- Adjusting camera angle
- Dial Back Light
- Door open by common password (Individual Flat Password)
- Door open with RF ID Card (Optional)
- Built in Controller (for 127 flats Max.)



Specifications

POWER SOURCE	+12V DC, 2.5A
COLOR	GOLD
DISPLAY	3.5 inch (8.9cm) TFT Color LCD
MOUNT TYPE	Wall Flush-mounted type
DATA COMMUNICATION	RS-485 (RF ID Card : 13.56MHz)
DIMENSIONS	198(W) X 274(H) X 10(D) mm
FLUSH BRACKET	350(W) x 261.5(H) x 100(D) mm

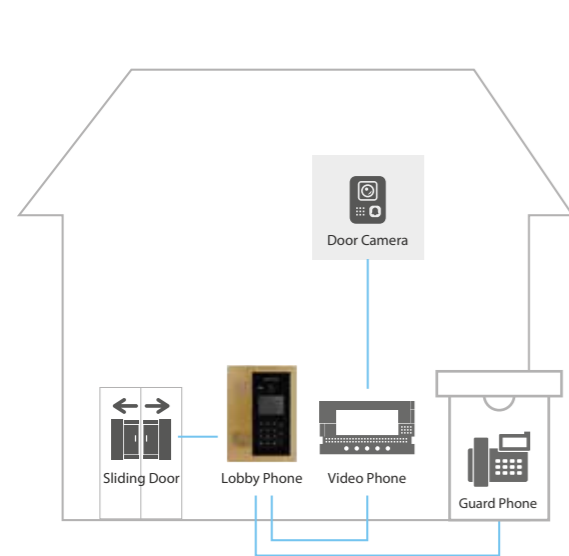
System Diagram

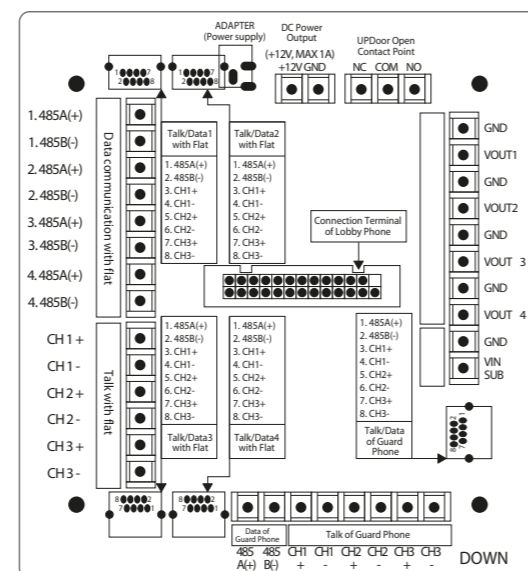

Connecting Diagram (Rear View)

Recommended Products



Main Controller UMS-100

ULP-200A

Lobby Phone

FEATURES & BENEFITS

- Call and Talk to flats
- Call and Talk to Guard Phone
- FND Display
- Aluminum die-casting
- Adjusting camera angle
- Door open by common password

Specifications

POWER SOURCE	+12V DC, 2.5A
COLOR	SILVER
MOUNT TYPE	Wall Flush-mounted type
DATA COMMUNICATION	RS-485
DIMENSIONS	230(W) X 280(H) X 39(D) mm
FLUSH BRACKET	221(W) x 256(H) x 92(D) mm

System Diagram

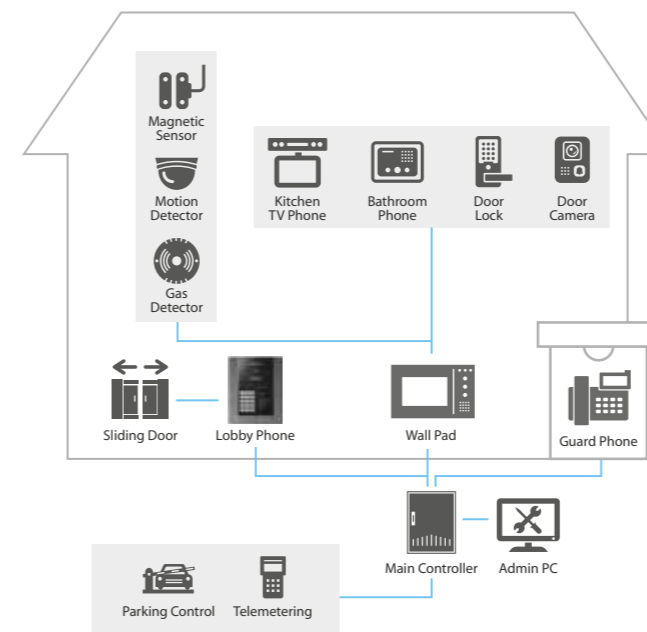

Connecting Diagram(Terminal Board)

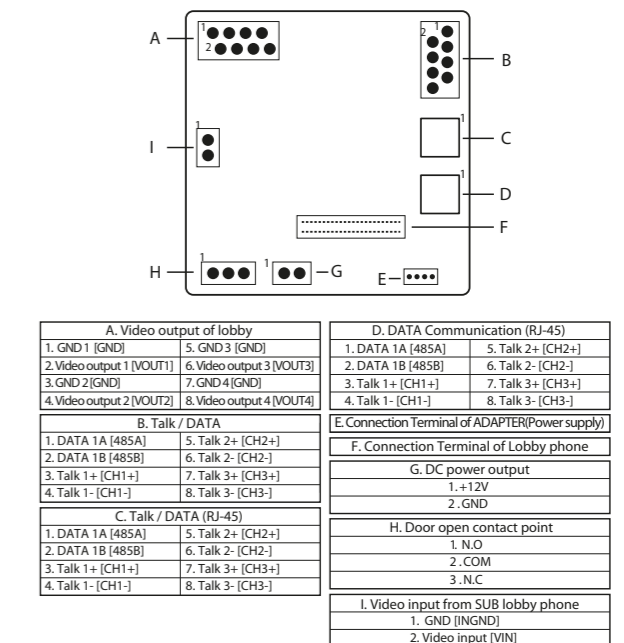

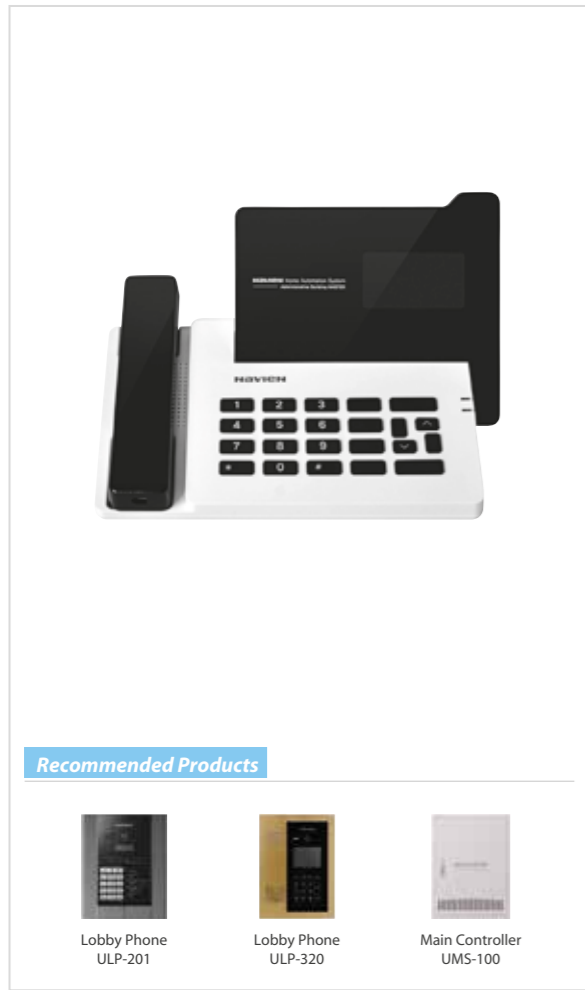

UGP-100

Guard Phone

FEATURES & BENEFITS

- Call and Talk with Flats or Lobby Phone
- Graphic LCD
- Call Forwarding (Between Flats)
- Absence mode (Detour call to another guard phone)
- Flat Emergency Alarm Display

Specifications

POWER SOURCE	+12V DC
DISPLAY	128 X 64 Dots LCD
DATA COMMUNICATION	RS-485
DATA DISTANCE	Less than 1,000m
TALK TYPE	Handset, Duplex

Recommended Products



Lobby Phone ULP-201



Lobby Phone ULP-320



Main Controller UMS-100

System Diagram

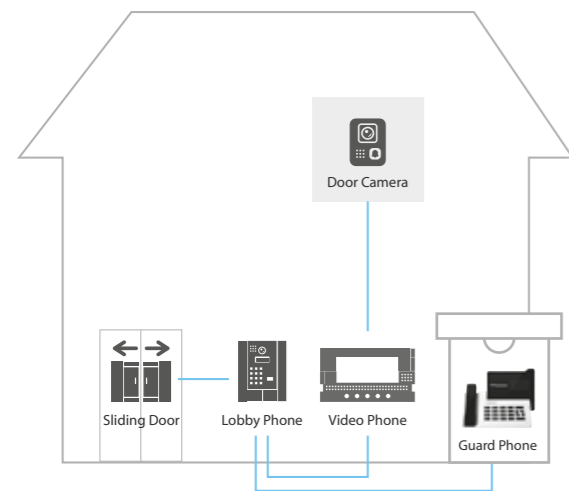

Connecting Diagram (Rear View)

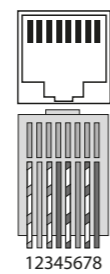

Cables (RJ-45)

RJ-45 Connector : Pin, No. and description

PIN NO	PIN NAME	POLARITY	DESCRIPTION
1	485 A	O	RS-485 DATA
2	485 B	O	RS-485 DATA
3	CH1 A	X	TALK CHANNEL 1
4	CH1 B	X	TALK CHANNEL 1
5	CH2 A	X	TALK CHANNEL 2
6	CH2 B	X	TALK CHANNEL 2
7	CH3 A	X	TALK CHANNEL 3
8	CH3 B	X	TALK CHANNEL 3

Color UPT Cables (Main controller Talk CH & DATA)

PIN No.	PIN COLOR
1	BLUE STRIPE
2	BLUE
3	ORANGE STRIPE
4	ORANGE
5	GREEN STRIPE
6	GREEN
7	BROWN STRIPE
8	BROWN



UMS-100

Main Controller

FEATURES & BENEFITS

- System Error Indication

Specifications

POWER SOURCE	100~240V AC, 50~60Hz
MOUNT TYPE	Wall surface mounted type
DATA COMMUNICATION	RS-485
DATA DISTANCE	Less than 1,000m
MAX . CAPACITY	1 of Mian Controller : 1,024 Devices including Room monitor, Lobby phone, ETC.
Slot FOR FLATS	MAX. 8(Each slot card covers 128 devices)
Slot FOR GUARD PHONE	Slot card covers 128 devices
TALK CHANNEL	EACH SLOT CARD : 3 CH BASIC : 16 CH ADDITIONAL : 8 CH
EXTENTION	MAX. 16 MAIN CONTROLLERS (16,384 DEVICES)
ADMIN PC	RS-485 to USB, or Serial USB
DISPLAY	LED (Status of data and channel occupation)
DIMENSIONS	452(W) X 603(H) X 117(D) mm

Recommended Products



Lobby Phone ULP-200A



Guard Phone UGP-100

System Diagram

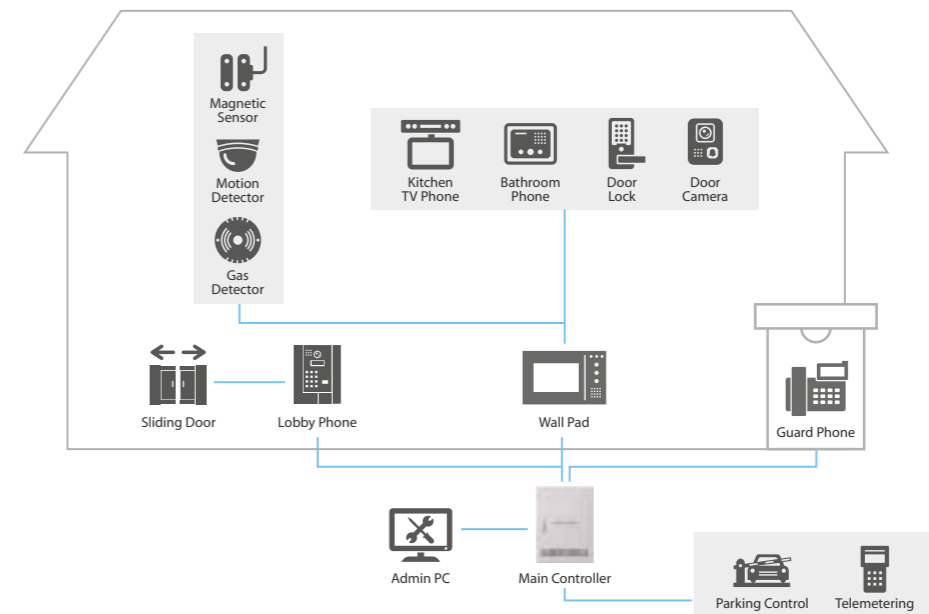

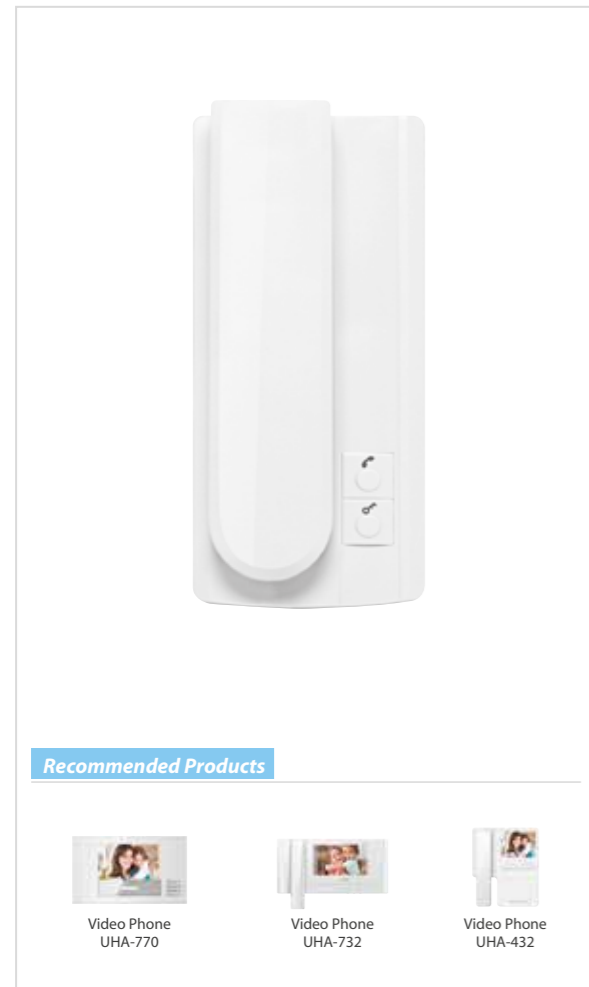

UIP-200

Audio Handset

FEATURES & BENEFITS

- Call and Talk to visitor, Door release

Specifications

POWER SOURCE	+14V DC (from monitor)
COLOR	WHITE
COMMUNICATION	Handset, Full Duplex
MOUNT TYPE	Wall surface mounted type
WIRING	1) Door Camera : 3 wires (Polarity) 2) Video Phone : 4 wires (Polarity)
DISTANCE	20m(TIV Ø0.65) (Between connected Video Phone and Audio handset) * Total Distance (Door Camera-Video Phone-Audio Handset) : It depends on the types of CABLE between Door camera and Video Phone. (28m(TIV Ø0.5), 50m(TIV Ø0.65), 70m(TIV Ø0.8))
DIMENSIONS	96.3(W) X 209.5(H) X 42.3(D) mm

System Diagram

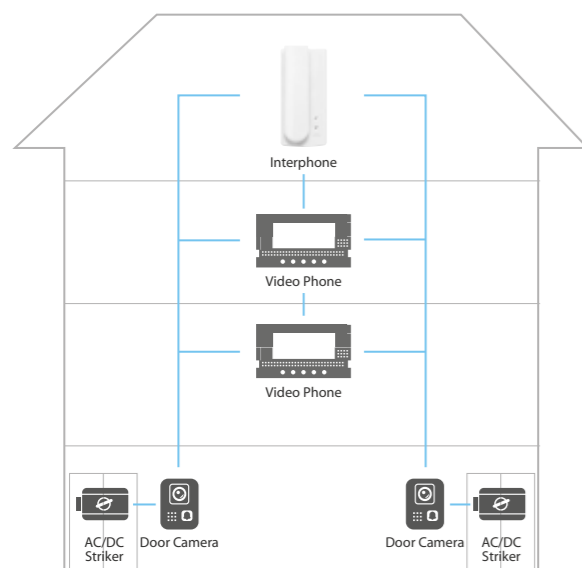

Connecting Diagram

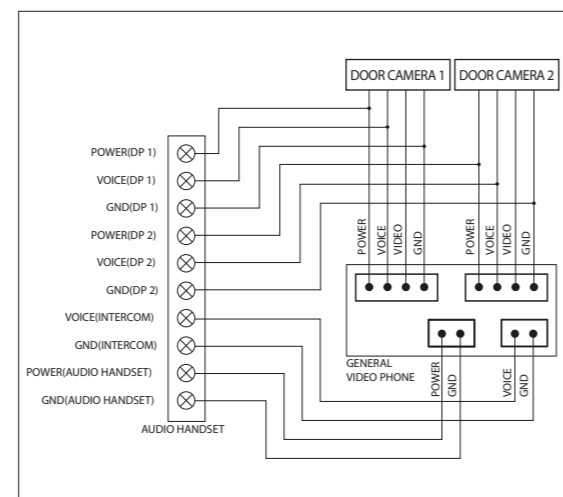

Office
 KD One Co.,Ltd
 7F, KOAMI Bldg., 22,Gukhoe-daero 76-gil,Yeongdeungpo-gu,
 Seoul, 07238, Korea
 KD One Global Business Dept.

Website
www.kdone.net

Contact Us
 Tel : +82-2-559-8357, E-mail : kjb@kdiwin.com
 Tel : +82-2-3489-2322, E-mail : tscho@kdiwin.com